

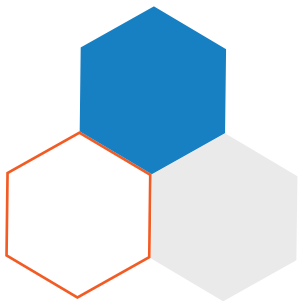

CONFERENCE TABLES

C A T A L O G

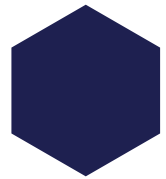
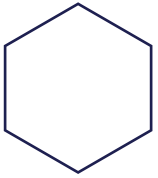

 FORMASPACE

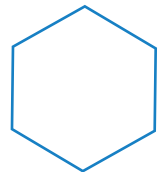

Conference Table



The Guitar Pick Table embodies a unique design language, showcasing Formaspace's expertise in crafting large-scale custom tables. The **distinctive central base** facilitates **unobstructed chair movement** around the table, maximizing seating capacity and fostering a sense of **collaboration**. This table transcends mere functionality, transforming into a **statement piece** through the integration of custom elements like the striking laser-cut logo. The work surface, finished in Wilsonart Laminate's Fawn Cypress, provides a touch of **sophistication** while ensuring **exceptional durability**.

Specifications as Seen at Neocon

- Laminate on Plywood Core, Fawn Cypress 8208K-16 (Worksurface)
- Black Texture Steel, BK59 (Frame)
- Black M10 Levelers
- LED Logo Cut into Base
- Black In-Surface Power

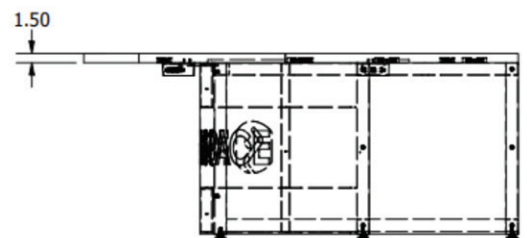
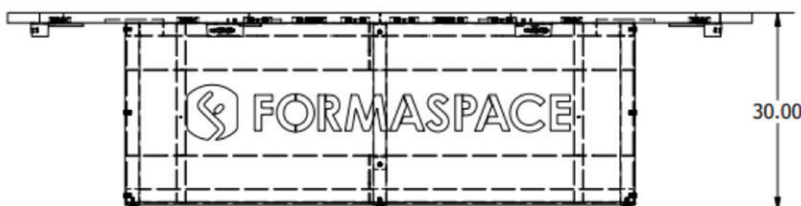
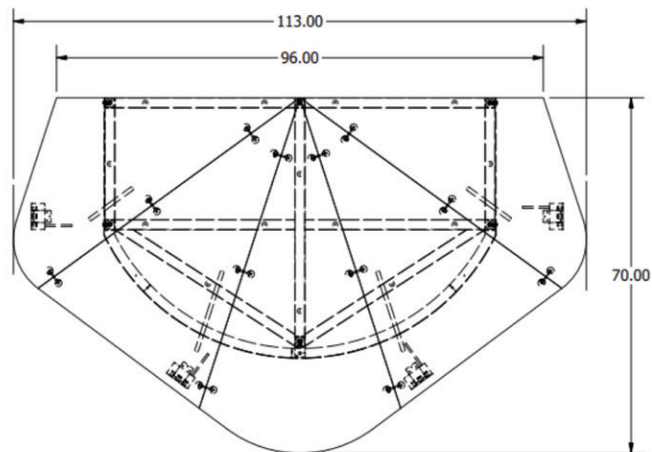

Finishes

Powder Coating Options for Frames

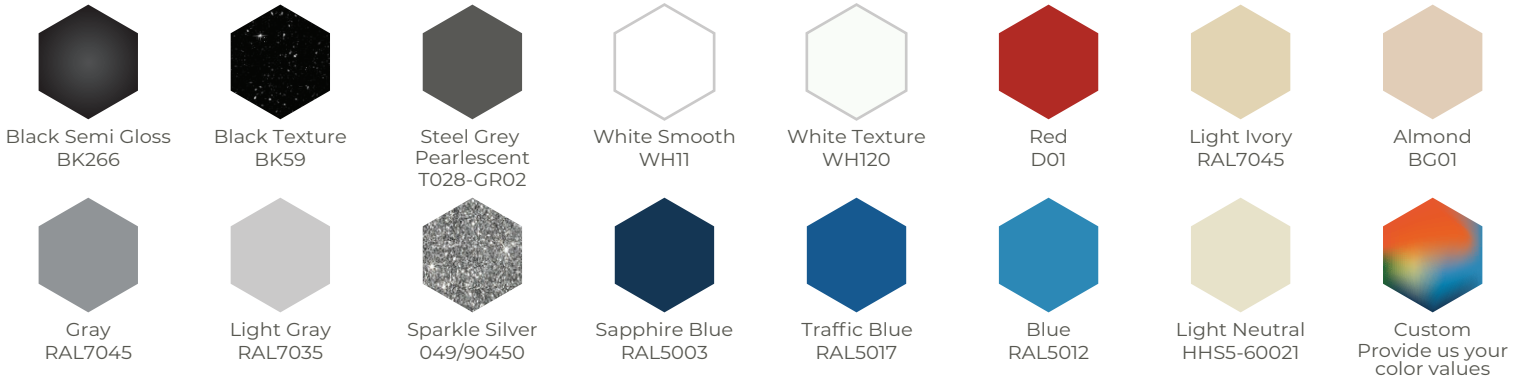

Hardwood and Laminate Options for Table Top

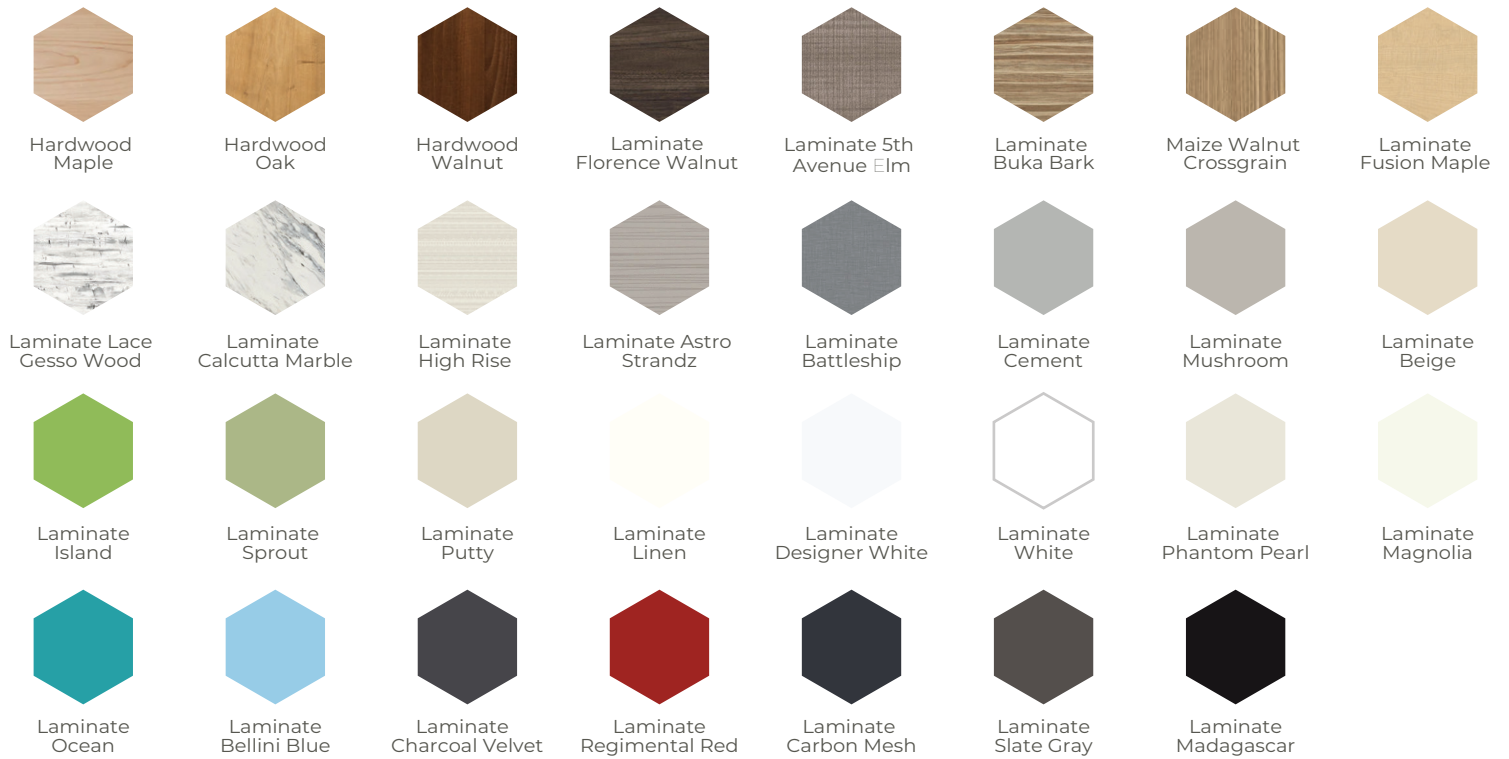



 **FORMASPACE**

 800.251.1505

 design.consultant@formaspace.com

 formaspace.com

