

Tensegrity Illusion Bench

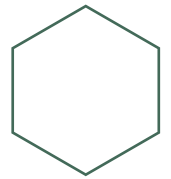

C A T A L O G

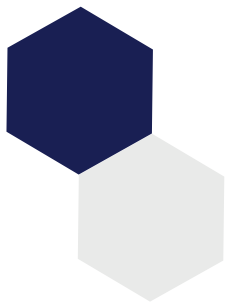

 FORMASPACE

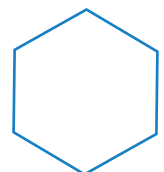

Tensegrity Illusion Bench

Description

- The Tensegrity Illusion Bench offers a captivating reimagining of the traditional bench seat. Its defining feature is the **offset cantilever leg design**, creating the illusion of the seat floating effortlessly on one side. This visually striking element adds a touch of intrigue to a traditionally straightforward design.
- **Beyond Aesthetics:** Incorporating bench seating into office and lab environments fosters interaction and informal collaboration. The highly modular and versatile nature of the Tensegrity Illusion Bench allows for a variety of configurations to suit your specific needs. Create gathering spaces that adapt and evolve alongside your team's collaborative spirit.
- **List Price as Shown:** \$2,887.50



Specifications as Seen at NeoCon

- 11GA 1.5" Tube Steel
- Laser-Cut Sheet Metal

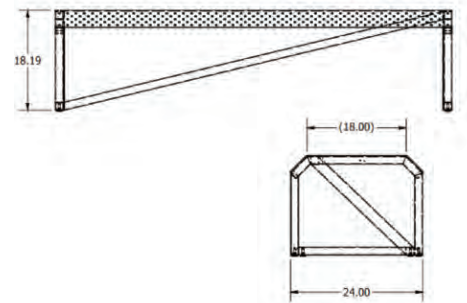
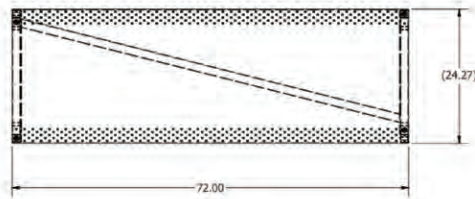

Finishes

Powder Coating Options





 800.251.1505

 design.consultant@formaspace.com

 formaspace.com